

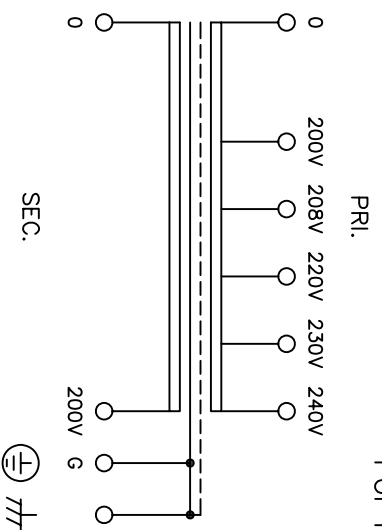





For indoor use only SPECIFICATION



STANDARD	EN61558-2-4	UL 506
MODEL	FUL22-3K	
PHASE	(Φ)	1
FREQUENCY	(Hz)	50/60
CAPACITY	(kVA)	3
PRI. VOLTAGE	(V)	200 208 220 230 240
SEC. VOLTAGE	(V)	200
SEC. CURRENT	(A)	15
PERCENT IMPEDANCE	(%)	3.3/3.4
DIELECTRIC STRENGTH (V/min)	P-S,G	4200
	S-G	4200
INSULATION RESISTANCE	more than 100 MΩ	
	at DC 500V Megger	
RATING	CONTINUOUS	
CLASS	H (SYSTEM 16)	
MASS	(kg)	29.9
MAX. AMBIENT TEMP.	(°C)	40
MAX. TEMP. RISE	(K)	125
PRI. CIRCUIT BREAKER	30A (EN60947-2)	120
SEC. CIRCUIT BREAKER	15A (EN60947-2)	
PROTECTION DEGREE	IP00	
IEC MARK	IP00	
TUV & CE MARK	 	
UL MARK		
UL FILE No.	E252316	

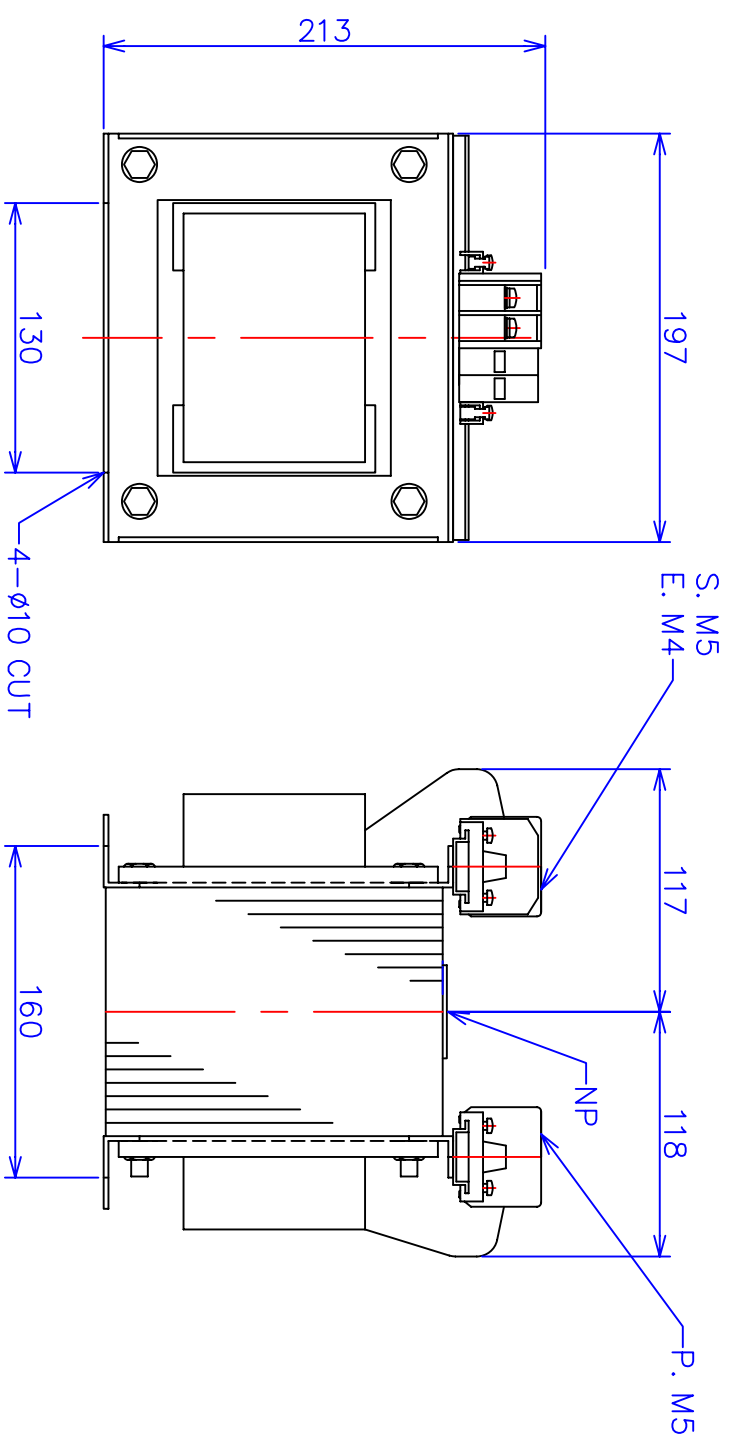

1	Geographical plot of a rated nameplate	2008/03/13
MARK	DESCRIPTIONS	DATE
REVISIONS		
NAME	DATE	SCALE
DRAWN BY K. Tamura	2006/12/20	✓
CHECKED BY K. Tamura	2006/12/20	⊕
FUKUDA ELECTRIC WORKS CO., LTD.		DRAWING No. T-42768-3K-M
		

TITLE TRANSFORMER